

Solid-state Timer H3YN

Miniature Timer with Multiple Time Ranges and Multiple Operating Modes

- Minimizes stock.
- Pin configuration compatible with MY Power Relay.
- Standard multiple operating modes and multiple time ranges.
- Conforms to EN61812-1 and IEC60664-1 for Low Voltage, and EMC Directives.



Model Number Structure

Model Number Legend

H3YN-□□-□
1 2 3

1. Output

- 2: DPDT
- 4: 4PDT

2. Time Range

- None: Short-time range (0.1 s to 10 min)
- 1: Long-time range (0.1 min to 10 hrs)

3. Contact Type

- None: Single contact
- Z: Twin contacts

Ordering Information

List of Models

Supply voltage	Time-limit contact	Short-time range model (0.1 s to 10 min)	Long-time range model (0.1 min to 10 h)
24, 100 to 120, 200 to 230 VAC; 12, 24, 48, 100 to 110, 125 VDC	DPDT	H3YN-2	H3YN-21
	4PDT	H3YN-4	H3YN-41
24 VDC	4PDT (Twin contacts)	H3YN-4-Z	H3YN-41-Z

Note: Specify both the model number and supply voltage when ordering.

Example: H3YN-2 24 VAC



Accessories (Order Separately)

Connecting Socket

Timer	Track mounting/Front Connecting Socket	Back Connecting Socket		
		Solder terminal	Wire-wrap terminal	PC terminal
H3YN-2/-21	PYF08A, PYF08A-N, PYF08A-E	PY08	PY08QN(2)	PY08-02
H3YN-4/-41 H3YN-4-Z/-41-Z	PYF14A, PYF14A-N, PYF14A-E	PY14	PY14QN(2)	PY14-02

Hold-down Clips

Model	Applicable Socket
Y92H-3	PYF08A, PYF08A-N, PYF08A-E PYF14A, PYF14A-N, PYF14A-E
Y92H-4	PY08, PY08QN(2), PY08-02 PY14, PY14QN(2), PY14-02

Specifications

■ Ratings

Item	H3YN-2/-4/-4-Z	H3YN-21/-41/-41-Z
Time ranges	0.1 s to 10 min (1 s, 10 s, 1 min, or 10 min max. selectable)	0.1 min to 10 h (1 min, 10 min, 1 h, or 10 h max. selectable)
Rated supply voltage	24, 100 to 120, 200 to 230 VAC (50/60 Hz) 12, 24, 48, 100 to 110, 125 VDC (see note 1)	
Pin type	Plug-in	
Operating mode	ON-delay, interval, flicker OFF start, or flicker ON start (selectable with DIP switch)	
Operating voltage range	85% to 110% of rated supply voltage (12 VDC: 90% to 110% of rated supply voltage) (see note 2)	
Reset voltage	10% min. of rated supply voltage (see note 3)	
Power consumption	100 to 120 VAC: Relay ON: approx. 1.8 VA (1.6 W) at 120 VAC, 60 Hz Relay OFF: approx. 1 VA (0.6 W) at 120 VAC, 60 Hz 200 to 230 VAC: Relay ON: approx. 2.2 VA (1.8 W) at 230 VAC, 60 Hz Relay OFF: approx. 1.5 VA (1.1 W) at 230 VAC, 60 Hz 24 VAC: Relay ON: approx. 1.8 VA (1.4 W) at 24 VAC, 60 Hz Relay OFF: approx. 0.3 VA (0.2 W) at 24 VAC, 60 Hz 12 VDC: Relay ON: approx. 1.1 W at 12 VDC Relay OFF: approx. 0.1 W at 12 VDC 24 VDC: Relay ON: approx. 1.1 W at 24 VDC Relay OFF: approx. 0.1 W at 24 VDC 48 VDC: Relay ON: approx. 1.2 W at 48 VDC Relay OFF: approx. 0.3 W at 48 VDC 100 to 110 VDC: Relay ON: approx. 1.6 W at 110 VDC Relay OFF: approx. 0.4 W at 110 VDC 125 VDC: Relay ON: approx. 1.6 W at 125 VDC Relay OFF: approx. 0.4 W at 125 VDC	
Control outputs	DPDT: 5 A at 250 VAC, resistive load ($\cos\phi = 1$) 4PDT: 3 A at 250 VAC, resistive load ($\cos\phi = 1$)	

- Note:**
1. Single-phase, full-wave-rectified power supplies can be used.
 2. When using the H3YN continuously in any place where the ambient temperature is in a range of 45°C to 50°C, supply 90% to 110% of the rated supply voltages (supply 95% to 110% with 12 VDC type).
 3. Set the reset voltage as follows to ensure proper resetting.
 - 100 to 120 VAC: 10 VAC max.
 - 200 to 230 VAC: 20 VAC max.
 - 100 to 110 VDC: 10 VDC max.

■ Characteristics

Item	H3YN-2/-21/-4/-41
Accuracy of operating time	±1% FS max. (1 s range: ±1%±10 ms max.)
Setting error	±10%±50 ms FS max.
Reset time	Min. power-opening time: 0.1 s max. (including halfway reset)
Influence of voltage	±2% FS max.
Influence of temperature	±2% FS max.
Insulation resistance	100 MΩ min. (at 500 VDC)
Dielectric strength	2,000 VAC, 50/60 Hz for 1 min (between current-carrying terminals and exposed non-current-carrying metal parts) (see note 1) 2,000 VAC, 50/60 Hz for 1 min (between operating power circuit and control output) 2,000 VAC, 50/60 Hz for 1 min (between different pole contacts; 2-pole model) 1,500 VAC, 50/60 Hz for 1 min (between different pole contacts; 4-pole model) 1,000 VAC, 50/60 Hz for 1 min (between non-continuous contacts)
Vibration resistance	Destruction: 10 to 55 Hz, 0.75-mm single amplitude for 1 h each in 3 directions Malfunction: 10 to 55 Hz, 0.5-mm single amplitude for 10 min each in 3 directions
Shock resistance	Destruction: 1,000 m/s ² Malfunction: 100 m/s ²
Ambient temperature	Operating: -10°C to 50°C (with no icing) Storage: -25°C to 65°C (with no icing)
Ambient humidity	Operating: 35% to 85%
Life expectancy	Mechanical: 10,000,000 operations min. (under no load at 1,800 operations/h) Electrical: DPDT: 500,000 operations min. (5 A at 250 VAC, resistive load at 1,800 operations/h) 4PDT: 200,000 operations min. (H3YN-4-Z/-41-Z: 100,000 operations min.) (3 A at 250 VAC, resistive load at 1,800 operations/h) (see note 2)
Impulse withstand voltage	Between power terminals: 3 kV for 100 to 120 VAC, 200 to 230 VAC, 100 to 110 VDC, 125 VDC 1 kV for 12 VDC, 24 VDC, 48 VDC, 24 VAC Between exposed non-current-carrying metal parts: 4.5 kV for 100 to 120 VAC, 200 to 230 VAC, 100 to 110 VDC, 125 VDC 1.5 kV for 12 VDC, 24 VDC, 48 VDC, 24 VAC
Noise immunity	±1.5 kV, square-wave noise by noise simulator (pulse width: 100 ns/1 μs, 1-ns rise)
Static immunity	Destruction: 8 kV Malfunction: 4 kV
Degree of protection	IP40
Weight	Approx. 50 g
EMC	(EMI) EN61812-1 Emission Enclosure: EN55011 Group 1 class A Emission AC Mains: EN55011 Group 1 class A (EMS) EN61812-1 Immunity ESD: EN61000-4-2: 8 kV air discharge (level 3) Immunity RF-interference from AM Radio Waves: EN61000-4-3: 10 V/m (80 MHz to 1 GHz) (level 3) Immunity Burst: EN61000-4-4: 2 kV power-line (level 3) 2 kV I/O signal-line (level 4) Immunity Surge: EN61000-4-5: 2 kV line to ground (level 3) 1 kV line to line (level 3)
Approved standards	UL508, CSA C22.2 No. 14, Lloyds Conforms to EN61812-1 and IEC60664-1. (2.5 kV/2 for H3YN-2/-21, 2.5 kV/1 for H3YN-4/-41, H3YN-4-Z/-41-Z) Output category according to EN60947-5-1.

- Note:** 1. Terminal screw sections are excluded.
2. Refer to the *Life-test Curve*.

Life-test Curve (Reference Value)

H3YN-2/-21

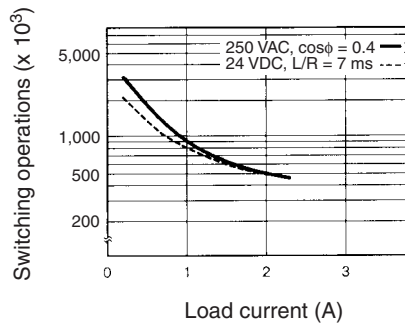
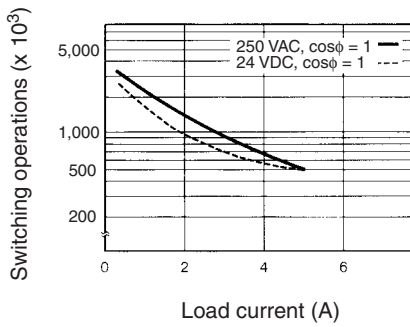

Reference: A maximum current of 0.6 A can be switched at 125 VDC (cosφ = 1).
Maximum current of 0.2 A can be switched if L/R is 7 ms. In both cases,
a life of 100,000 operations can be expected.
 The minimum applicable load is 1 mA at 5 VDC (P reference value).

H3YN-4/-41

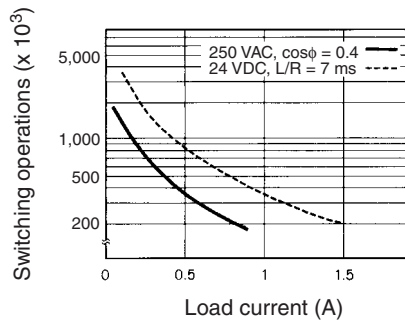
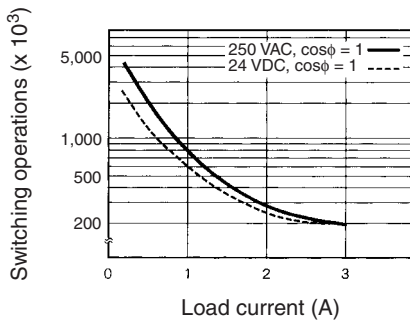

Reference: A maximum current of 0.5 A can be switched at 125 VDC (cosφ = 1).
Maximum current of 0.2 A can be switched if L/R is 7 ms. In both cases,
a life of 100,000 operations can be expected.
 The minimum applicable load is 1 mA at 1 VDC (P reference value).

H3YN-4-Z/-41-Z

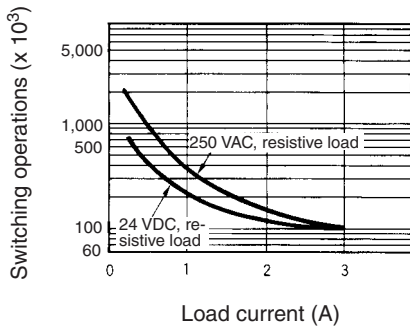

Reference: A maximum current of 0.5 A can be switched at 125 VDC (cosφ = 1).
Maximum current of 0.2 A can be switched if L/R is 7 ms. In both cases,
a life of 100,000 operations can be expected.
 The minimum applicable load is 0.1 mA at 1 VDC (P reference value).

Connections

Connection

H3YN-2/-21

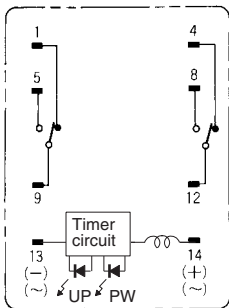

DIN Indication

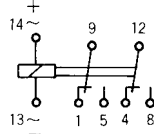

H3YN-4/-41
H3YN-4-Z/-41-Z

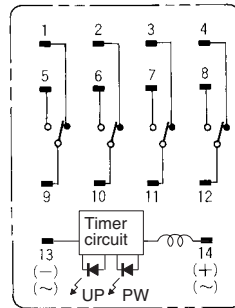

DIN Indication

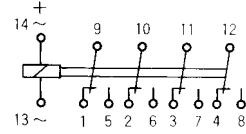

Pulse Operation

A pulse output for a certain period can be obtained with a random external input signal.

Use the H3YN in interval mode as shown in the following timing charts.

H3YN-2/-21

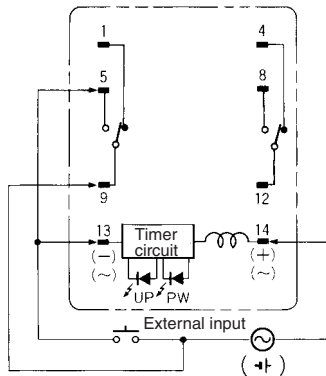

- Power (9-14)
- External short circuit (5-13)
- External input (9-13)
- Time limit contact NO (12-8)
- Time limit contact NC (12-4)
- Run/Power indicator (PW)
- Output indicator (UP)

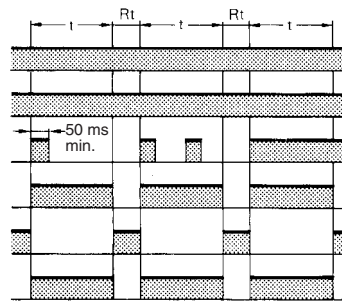

Note: t: Set time
Rt: Reset time

H3YN-4/-41

H3YN-4-Z/-41-Z

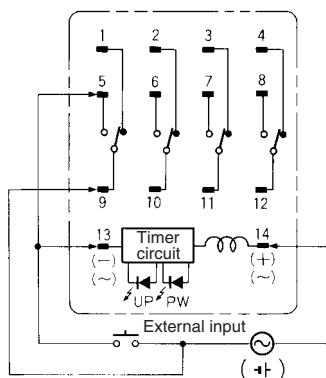

- Power (9-14)
- External short circuit (5-13)
- External input (9-13)
- Time limit contact NO (10-6, 11-7, 12-8)
- Time limit contact NC (10-2, 11-3, 12-4)
- Run/Power indicator (PW)
- Output indicator (UP)

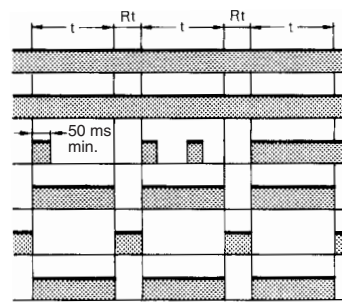

Note: t: Set time
Rt: Reset time

Caution

Be careful when connecting wires.

Mode	Terminals
Pulse operation	Power supply between 9 and 14 Short-circuit between 5 and 13 Input signal between 9 and 13
Operating mode; interval and all other modes	Power supply between 13 and 14

Operation

■ Timing Chart

Operating mode	Timing chart	
	H3YN-2/-21	H3YN-4/-41
ON-delay 		
Interval 		
Flicker OFF-start 		
Flicker ON-start 		

Note: t: Set time
Rt: Reset time

DIP Switch Settings

The 1-s range and ON-delay mode for H3YN-2/-4/-4-Z, the 1-min range and ON-delay mode for H3YN-21/-41/-41-Z are factory-set before shipping.

Time Ranges

Model	Time range	Time setting range	Setting	Factory-set
H3YN-2, H3YN-4 H3YN-4-Z	1 s	0.1 to 1 s		Yes
	10 s	1 to 10 s		No
	1 min	0.1 to 1 min		No
	10 min	1 to 10 min		No
H3YN-21, H3YN-41 H3YN-41-Z	1 min	0.1 to 1 min		Yes
	10 min	1 to 10 min		No
	1 h	0.1 to 1 h		No
	10 h	1 to 10 h		No

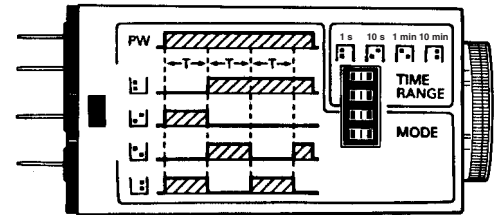

Note: The top two DIP switch pins are used to select the time ranges.

Operating Modes

Operating mode	Setting	Factory-set
ON-delay		Yes
Interval		No
Flicker OFF-start		No
Flicker ON-start		No

Note: The bottom two DIP switch pins are used to select the operating mode.

Nomenclature

Output Indicator (Orange)
(Lit: Output ON)

Main Dial
Set the desired time according to time range selectable by DIP switch.

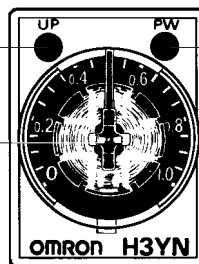

Run/Power Indicator (Green)
(Lit: Power ON)

Dimensions

Note: All units are in millimeters unless otherwise indicated.

Timers

H3YN-2/-21 Front Mounting

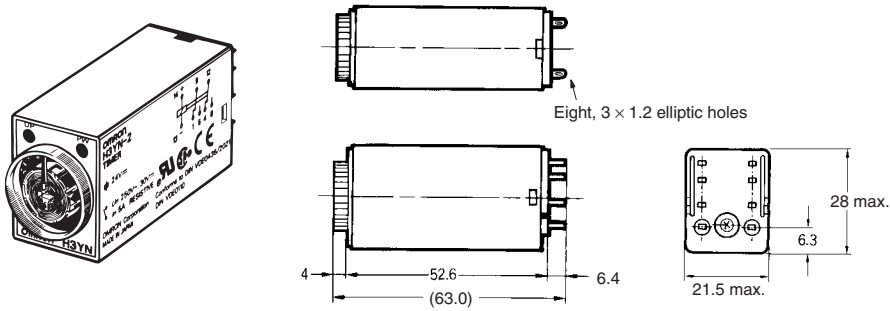

H3YN-4/-41 Front Mounting H3YN-4-Z/-41-Z

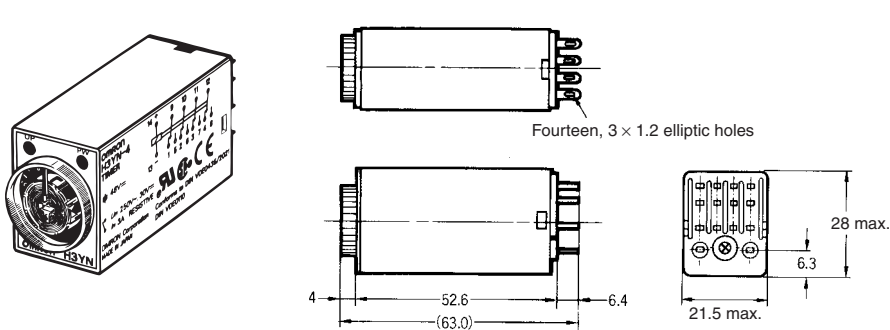

Mounting Height

PYF08A/PYF08A-N/PYF08A-E
(PYF14A/PYF14A-N/PYF14A-E
(see note))

PY08 (PY14 (see note))

PY08QN (PY14QN (see note))

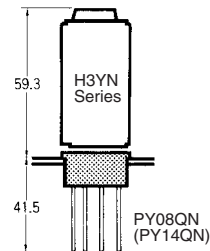
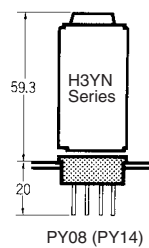
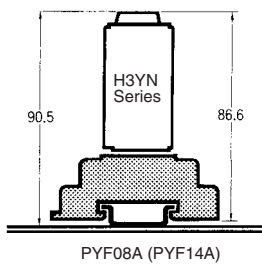

Note: Models in parentheses are Connecting Sockets to the H3YN-4/-41 or H3YN-4-Z/-41-Z.

■ Accessories (Order Separately)

Connecting Sockets

Use the PYF□A, PY□, PY□-02, or PY□QN(2) to mount the H3YN. When ordering any one of these Sockets, replace "□" with "08" or "14."

Track Mounting/Front Connecting Sockets

PYF08A

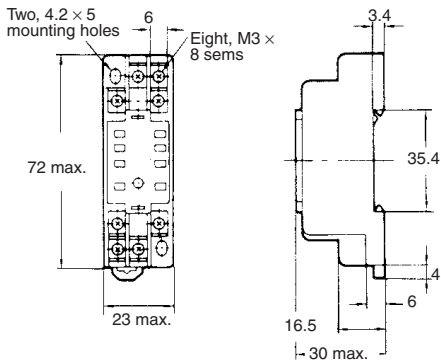

Terminal Arrangement (Top View)

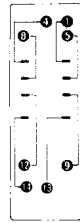

Mounting Holes

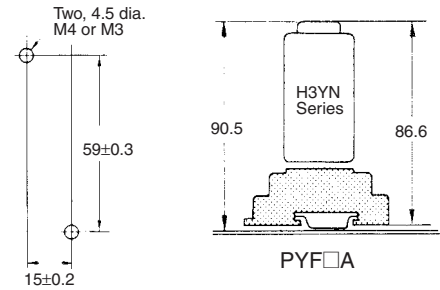

PYF-14A

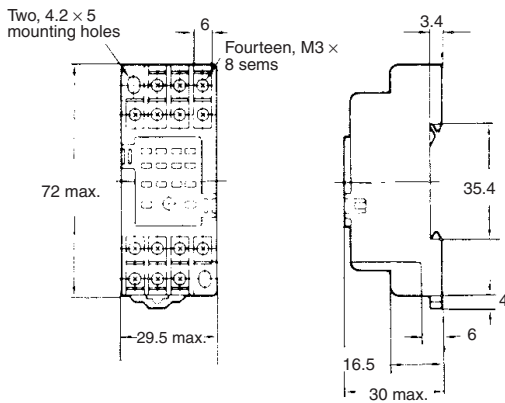

Terminal Arrangement (Top View)



Mounting Holes

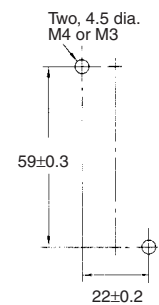

PYF-08A-N

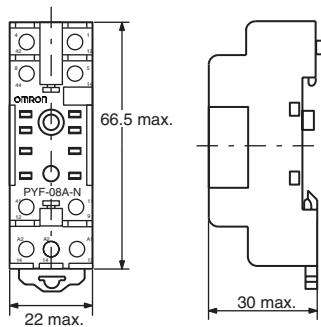

Terminal Arrangement

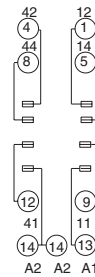

Mounting Holes (for Surface Mounting)

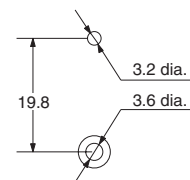

PYF-14A-N

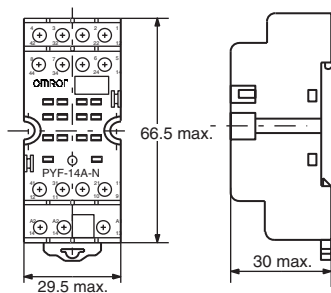

Terminal Arrangement

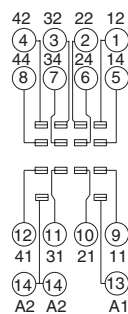

Mounting Holes (for Surface Mounting)

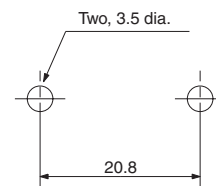

PYF08A-E

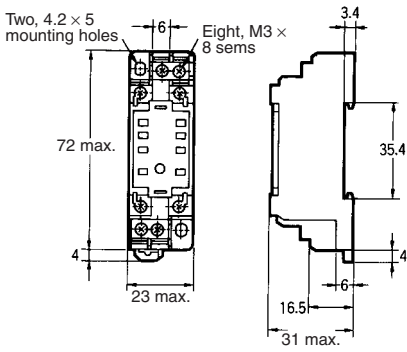

(Top View)

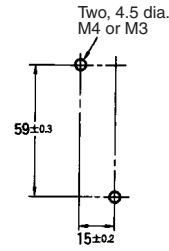
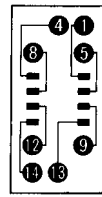

PYF14A-E

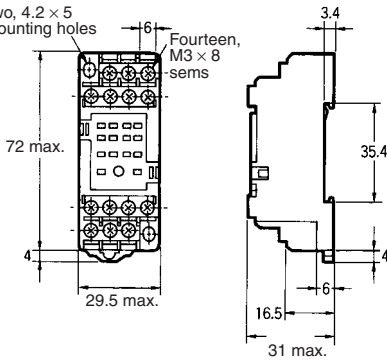

(Top View)

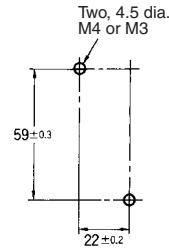
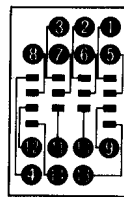

**Back Connecting Sockets
PY08, PY14**

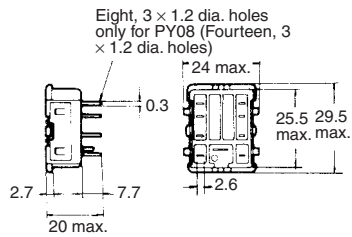

**Terminal Arrangement
(Bottom View)**

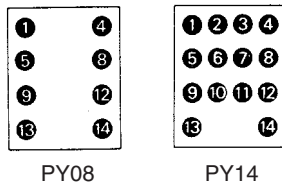

Panel Cutout

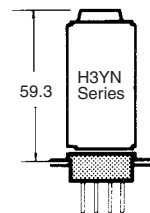
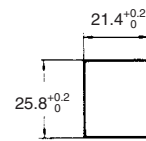

PY□, PY□-02,
PY□QN(2)

**PY08QN, PY14QN
PY08QN(2), PY14QN(2)**

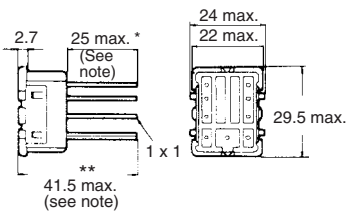

**Terminal Arrangement
(Bottom View)**

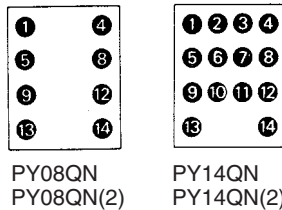

Note: With PY□QN(2)-(3), dimension * should read 20 max. and dimension ** 36.5 max.

PY08-02, PY14-02

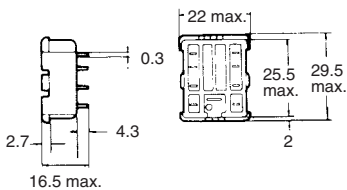

**Terminal Arrangement
(Bottom View)**

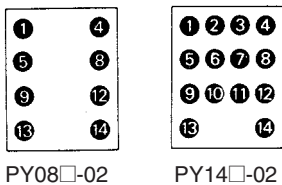

Flush Mounting Adapter

Y92F-78

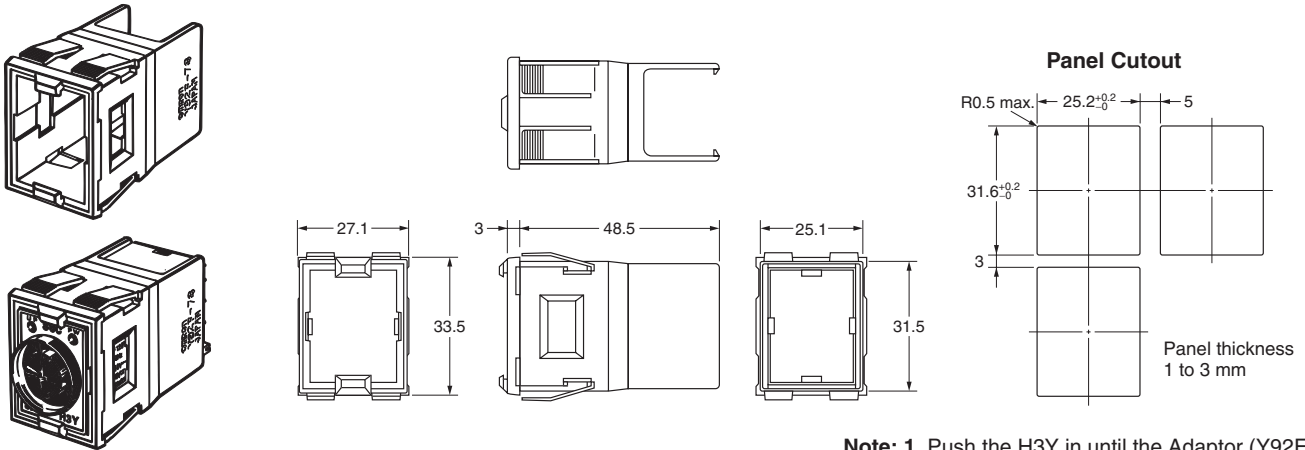

- Note:**
1. Push the H3Y in until the Adaptor (Y92F-78) hooks engage with its rear panel.
 2. Do not round the corners of the cutout on the rear panel surface, otherwise the Adaptor (Y92F-78) tabs may not engage properly.

Socket Mounting Plates

The PYP-1 is a Socket Mounting Plate for a single Socket and the PYP-18 is a Socket Mounting Plate for 18 Sockets. The PYP-18 can be cut appropriately according to the number of Sockets to be used.

PYP-1

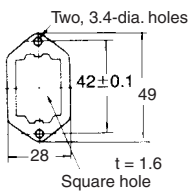
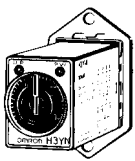

PYP-18

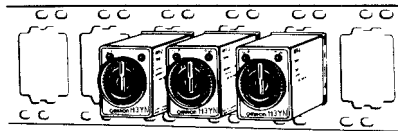
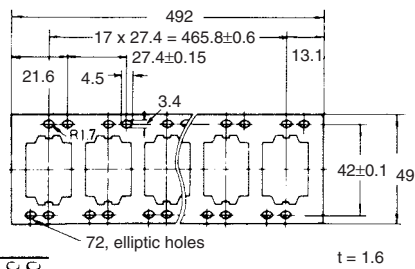

Hold-down Clips

The Hold-down Clip makes it possible to mount the H3YN securely and prevent the H3YN from falling out due to vibration or shock.

Y92H-3
Y92H-4

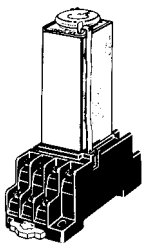

Y92H-3 for
PYF□A Socket
(Set of Two Clips)

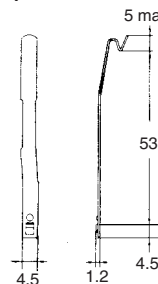

Y92H-4 for
PY□ Socket

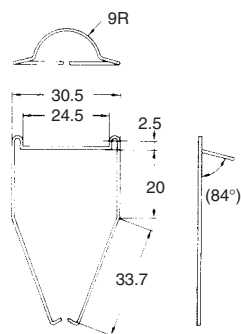

Precautions

■ Correct Use

The operating voltage will increase when using the H3YN continuously in any place where the ambient temperature is in a range of 45°C to 50°C. Supply 90% to 110% of the rated voltages (at 12 VDC: 95% to 110%).

Do not leave the H3YN in time-up condition for a long period of time (for example, more than one month in any place where the ambient temperature is high), otherwise the internal parts (aluminum electrolytic capacitor) may become damaged. Therefore, the use of the H3YN with a relay as shown in the following circuit diagram is recommended to extend the service life of the H3YN.

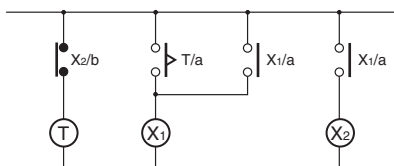

⊗: Auxiliary relay such as MY Relay

The H3YN must be disconnected from the Socket when setting the DIP switch, otherwise the user may touch a terminal imposed with a high voltage and get an electric shock.

Do not connect the H3YN as shown in the following circuit diagram on the right hand side, otherwise the H3YN's internal contacts different from each other in polarity may become short-circuited.

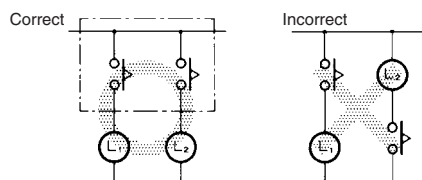

Use the following safety circuit when building a self-holding or self-resetting circuit with the H3YN and an auxiliary relay, such as an MY Relay, in combination.

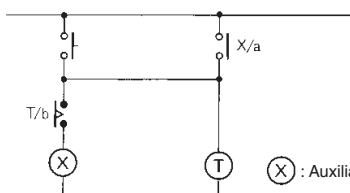

⊗: Auxiliary relay such as MY Relay

In the case of the above circuit, the H3YN will be in pulse operation. Therefore, if the circuit shown on page 89 is used, no auxiliary relay will be required.

Do not set to the minimum setting in the flicker modes, otherwise the contact may become damaged.

Be careful not to apply any voltage to the terminal screws on the back of the Timer. Mount the product so that the screws will not come in contact with the panel or metal parts.

Do not use the H3YN in places where there is excessive dust, corrosive gas, or direct sunlight.

Do not mount more than one H3YN closely together, otherwise the internal parts may become damaged. Make sure that there is a space of 5 mm or more between any H3YN models next to each other to allow heat radiation.

The internal parts may become damaged if a supply voltage other than the rated ones is imposed on the H3YN.

In order to conform to UL and CSA requirements when using the H3YN-4/-41 or H3YN-4-Z/-41-Z, connect the Unit so that output contacts (contacts of different poles) have the same electric potential.

In cases such as PLC input where the load is extremely small for the control output of a timer containing a power relay (using other than gold-plated contacts), reliability can be increased by using contacts of the same poles (e.g., the H3Y-2) in parallel.

■ Precautions for EN61812-1 Conformance

The H3YN as a built-in timer conforms to EN61812-1 provided that the following conditions are satisfied.

Handling

Do not touch the DIP switch while power is supplied to the H3YN. Before dismounting the H3YN from the Socket, make sure that no voltage is imposed on any terminal of the H3YN.

The applicable Socket is the PYF□A.

Only basic insulation is ensured between the Y92H-3 Hold-down Clips and H3YN internal circuits.

Do not allow the Y92H-3 Hold-down Clips to contact other parts.

The insulation test voltage between different pole contacts for the 4-pole model is the impulse voltage of 2.95 kV.

Wiring

The power supply for the H3YN must be protected with equipment such as a breaker approved by VDE.

Basic insulation is ensured between the H3YN's operating circuit and control output.

Basic insulation: Overvoltage category II, pollution degree 1 (H3YN-4/-41, H3YN-4-Z/-41-Z), pollution degree 2 (H3YN-2/-21) (with a clearance of 1.5 mm and a creepage distance of 2.5 mm at 240 VAC)

ALL DIMENSIONS SHOWN ARE IN MILLIMETERS.
To convert millimeters into inches, multiply by 0.03937. To convert grams into ounces, multiply by 0.03527.