

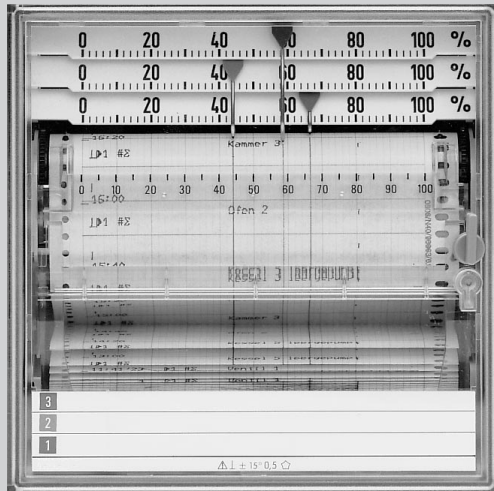

Line recorder KS 3930 A KS 3930 B



Galvanically isolated input channels for simple connection

Measuring and recording range freely configurable

Maintenance-free recording system

Universal cassette for roll or Z-fold chart paper

6 limit values with free channel allocation

Optional:

isolated 24 VDC output

digital input & output

Additionally with KS 3930 A:

Alpha-numeric printing system for recording date, time, texts, and other information

PROFILE

The KS 3930 is an industrial line recorder with microprocessor control and max. 3 channels. Its front dimensions are 144 x 144 mm. There are two basic versions:

KS 3930 B

This is a low-cost recorder with two different input circuits:

- a) Standard
For DC input (e. g. standard 0/4... 20 mA or 0... 10V signals).
- b) Universal
Extended measurement value table for DC signals (mA, mV, V), thermocouples, resistance thermometers and potentiometric transducers.

KS 3930 A

This version offers the same functions as the KS 3930 B, but is always fitted with the universal input circuit.

Furthermore, it also has:

- an alpha-numeric printing system for recording date, time, texts, event marking, measurement value table, etc.

Both basic versions are freely programmable without any accessory equipment. Alternatively, the recorders can be configured remotely, from a PC which is connected via a front-panel interface socket. A suitable Engineering Tool is available as a software package.

With numerous functions and robust construction, the KS 3930 A/B line recorders are ideal for universal industrial applications.

OPERATING PRINCIPLE

The input channels are polled by a wear-free semiconductor scanner which also provides galvanic isolation. The A/D converter works with high resolution, so that even small measuring spans can be processed accurately.

Non-linear input signals, e.g. from thermocouples and resistance thermometers, are corrected, so that display and recording are temperature-linear.

The microprocessor controls the stepping motors for chart drive and the recording systems. Digital technology eliminates wear-prone components such as DC motors, cord drives, and feedback potentiometers, so that the recorders are practically maintenance-free.

CONSTRUCTION

The recorder is fitted in a sheet-steel housing for panel mounting. The front door gives protection type IP54 (splash water).

The chassis is retained in the housing by means of a locking lever. After unlocking, the chassis can be drawn forwards, e. g. for convenient pen replacement. For servicing, the chassis can be removed completely.

A ribbon cable with plug connects the chassis with the CPU. The power supply is fitted to the housing rear, thus ensuring good heat convection and minimum self-heating of the recorder.

A universal chart cassette permits using Z-fold or roll charts. For roll charts, a take-up spool is delivered with the accessories. The paper start is caught and wound up automatically.

TECHNICAL DATA

INPUT

Measurement inputs

No. of channels: 1, 2 or 3, galvanically isolated via semiconductor switches.
Max. voltage against protective earth: 24 VDC
Excess voltage protection is provided by Varistors.

Measurement principle

A/D conversion according to the Dual-Slope-Method
Resolution: 14 bits
Channel cycle time: 40 ms with 50 Hz

Permissible continuous overload

Max. 24V, max. 40 mA

Interference suppression

Common mode: 90 dB with 50 Hz
Series mode: 60 dB with 50 Hz

Signal attenuation

1st-order low-pass filter adjustable
0-1-3-10-30-100 s or with automatic matching to chart speed.

Reference conditions

Ambient temperature: 21...25 °C
Relative humidity: 50...60%
Source resistance: < 1kΩ
Potential difference: < 1V

STANDARD INPUT (U / I)

Measurement cycle

Normal: 240 ms
Fast: 150 ms

Input resistance

Direct voltage: 100kΩ
Direct current: 50Ω

Measurement ranges

Separately configurable for each channel.

Span	Resolution	Max. error
Direct voltage (DC U)		
-1...+1V	0,1mV	1mV
0... 1V	0,1mV	1mV
0,2...1V	0,1mV	1mV
-10...+10V ¹⁾	1mV	11mV
0... 10V	1mV	11mV
2... 10V	1mV	11mV
Direct current (DC I)		
-20...+20mA	2μA	22μA
0... 20mA	2μA	22μA
4... 20mA	2μA	22μA

¹⁾ -20...+20V configurable

Recording range

Freely configurable within the selected input span, for example:
Input span -20...+20 mA
Recording range -2,5...+15,0 mA

UNIVERSAL INPUT (U / I / TC / RTD / R)

Measurement cycle

Normal: 300 ms
Fast: 180 ms

Input signals

Direct voltage (U)

For input signals $\leq 100\text{mV}$:
Input resistance > 10MΩ
Source resistance < 10kΩ
For input signals $\geq 1\text{V}$:
Input resistance 100kΩ

Direct current (I)

Input resistance 50Ω

Thermocouples (TC)

Input resistance > 10MΩ
Internal or external cold-junction compensation configurable.
Error of internal CJC: approx. 0,5K

Measurement ranges

Separately configurable for each channel.

Input signal	Span	Resolution	Max. error
Direct voltage (DC U)			
- 40... 40mV		4μV	36μV
- 100... 100mV		10μV	80μV
- 400... 400mV		40μV	320μV
-1000... 1000mV		100μV	800μV
- 1... +1V		0,1mV	1mV
0... 1V		0,1mV	1mV
0,2... 1V		0,1mV	1mV
- 10... +10V ¹⁾		1mV	11mV
0... 10V		1mV	11mV
2... 10V		1mV	11mV
Direct current (DC I)			
- 20... +20mA		2μA	22μA
0... 20mA		2μA	22μA
4... 20mA		2μA	22μA
Thermocouples (TC) to DIN IEC 348²⁾			
Type J Fe-CuNi	(-210) -100...1200°C	0,2K	1,3K
Type K NiCr-Ni	(-270) -100...1370°C	0,3K	1,6K
Type R Pt13Rh-Pt	(- 50) 100...1760°C	0,5K	1,8K
Type T Cu-CuNi	(-270) -100... 400°C	0,2K	0,9K
Type S Pt10Rh-Pt	(- 50) 100...1760°C	0,5K	1,8K
Type N NiCrSi-NiSi	(-200) -100...1300°C	0,4K	1,7K
Type E NiCr-CuNi	(-270) -100...1000°C	0,2K	1,1K
Type B Pt30Rh-Pt6Rh	(100) 600...1820°C	0,6K	2,0K
Thermocouples (TC) to DIN 43 710²⁾			
Type L FeCu-Ni	(-200) -100... 900°C	0,2K	1,1K
Type U CuCu-Ni	(-200) -100... 560°C	0,2K	1,0K
Resistance thermometer (RTD)			
Pt100 DIN IEC 751	-200... 850°C	0,05K	0,9K
Ni100 DIN 43710	- 60... 180°C	0,05K	0,4K
Potentiometric transducer (R)			
	0... 300Ω	0,03Ω	0,4Ω
	0...1000Ω	0,1Ω	1,2Ω

¹⁾ -20...+20V configurable

²⁾ Slightly higher errors apply for the ranges in brackets.

Reference temperature of external CJC: configurable for 0, 20, 50, or 70 °C via reference channel.

Action on sensor break: configurable for < 0 or > 100% of recording range

Resistance thermometer (RTD) and potentiometric transducer (R)

Connection with 3 or 2 leads configurable.

With 2-lead connection, lead resistance must be adjusted to 10Ω.

Recording range

Freely configurable within the selected input span, for example:
Pt 100, input span -200...850 °C
Recording range -50...80 °C

DISPLAY AND RECORDING

Display and recording range

Freely configurable within the selected input span by means of „Value left“ and „Value right“.

Scale

3 separate scale strips, each with one graduation.
Length: 100 mm

Drive for recording system

Program-controlled stepping motor.
Resolution: 0,1 mm
Slewing speed: max. 40 mm/s
Recording width: 100 mm

Mechanical recording error

≤ 0,35% of recording width

Recording pens

Replaceable.
Automatic pen lift when recording stops.
Colours: red (1), blue (2), green (3)
Trace length: approx. 2000 m
Pen life: max. 6 months
Storage life: approx. 2 years
Pen offset with multi-channel versions: 1,5 mm

Chart drive

Program-controlled stepping motor.
Step length: 0,02 mm
Chart speed: 0-1-1,25-2,5-5-10-20-60-120-300-600-1200 mm/h, configurable

Chart paper

Universal cassette for Z-fold or roll charts to DIN 16 230
Chart width: 120 mm
Recording width: 100 mm

Z-fold charts

Length 16m, fold depth 40 mm, visible chart 30...80 mm

Roll charts

Length 31 m, visible chart 70...80 mm, automatic chart take-up

ONLY WITH VERSION KS 3930 A

Alpha-numeric printing system

Replaceable pen, black.
Useful life: approx. 100 000 characters
Printing speed: 0,4 characters/s

The following are printed:

- Date, time, chart speed, one recorder and up to 6 event texts.
Max. 20 characters per text.
Printing is cyclical or triggered by an alarm or external signal.
- Measurement value table, cyclical every 1, 2, 3, 4 or 12 hours, or triggered by an alarm or an external signal.
- Limit lines and alarm marks along the recorded trace.

- Configuration data.
- Scale graduation every 20 mm, divisions configurable from 1/4 to 1/7
- 2 event channels for recording ON/OFF signals, triggered by an alarm or an external signal.

Real-time clock

For printing of date/time in 12 or 24-hour mode, summer/winter time switch-over.
Clock is buffered with built-in CR2032 lithium battery, useful life > 3 years with recorder switched off.

OPERATION

By means of built-in keys and display elements.

Operating level

Start/Stop of recorder
Fast chart speed

Programming level

Measurement and recording ranges
Alarm settings
Chart speed
and other functions.

Testing level

Test functions
Service functions
Program blocking
and other functions.

PC interface

For remote configuration and polling of measurement values via a PC.
The interface socket is accessible from the front. The necessary adapter cable and Engineering Tool software must be ordered separately, see „Accessories“.

ALARMS

6 limits values, configurable for MIN or MAX operation, free allocation to the recording channels.
Switching hysteresis of alarm output: 2% of recording range

OPTIONS

Digital inputs/outputs

Control inputs:
Quantity: 4 (DI1...DI4), passive, galvanically isolated via opto-coupler
Switching levels:
Low: -3...+5V
High: +8...+30V
Input resistance: > 5kΩ
Signal duration: > 5 seconds
Max. 4 of the following functions can be selected and allocated to the inputs:
Chart-speed switch-over A/B
Start/Stop of recording

1...6 event texts, 1 recorder text
2 event channels, measurement value table
Fast/slow recording
Chart feed 10 to 100 mm
Summer time ... etc.

Alarm outputs:

6 output relays with potential-free switch-cover contacts.
Contact rating: max. 50 V, 1 A, 30 W or 60 VA

Voltage output

24 VDC, ± 15%, max. 75mA, short-circuit proof, galvanically isolated, capacitive load max. 33µF.
Used e.g. for:
Two-wire transmitter supply or for energizing the control inputs.

POWER SUPPLY

AC voltage

230V, 115V or 24V, 47...64Hz
Tolerance range: -20...+15%
Power consumption: approx. 20 VA

DC voltage

24 VDC, -20...+15%, approx. 13W

ENVIRONMENTAL CONDITIONS

Permissible temperatures

For operation: 0...50 °C
For storage: -25...70 °C

Climatic category

KWF to DIN 40 040
Relative humidity ≤ 75% yearly average, no condensation

Vibration test: IEC 68-2-6

Mounting position

Front vertical with max. ± 15 ° inclination to DIN 16 257.

CONFORMITY TESTS

The instrument has CE-marking.

Electrical safety

Meets EN 61 010-1.
Excess voltage category II
Contamination degree 2
Protective class I (protective earth connection) to VDE 0411, Part 1

Electromagnetic compatibility

Complies with EN 50 081-1 and EN 50 082-2.
Meets NAMUR recommendation NE 21.

GENERAL

Housing

For mounting in a panel cut-out.
Material: sheet steel, grey finish
Transparent plastic door with catch.
For dimensions, see Fig. 1
Mounting to DIN 43 834-A-230.

Protection mode

According to IEC 529 (EN 60 529)
Front with door: IP 54
Terminals: IP 20

Electrical connections

Signal inputs:
Screw terminals for max. 2,5 mm² solid
or 1,5 mm² flexible with sleeve

Control inputs and alarm outputs:
Via 25-pin D-type connector socket
(plug is provided with recorder)

230/115 VAC supply:

Appliance connector to IEC 320.
(plug is provided with recorder)

24 VAC/DC supply:

Screw terminals

Weight

approx. 4 kg
(5,5 kg packed weight)

Packaging dimensions

Overall: 490 x 290 x 290 mm

Statistical article code

HS-Code 90308390

Accessories

- 2 Fixing clamps
- 1 Z-fold chart
- 1 Recording pen per channel
- 1 Pen for the alpha-numeric printing system with KS 3930 A
- 1 Chart-reading rule per graduation
- 1 Mains connector with 230/115 VAC supply
- 2 Fuses
- 1 Take-up spool for roll charts
- 1 Installation instruction (GB, D, F, E, I)
- 1 Manual „Operation, quick reference“ (1xGB, 1xD, 1xF)
- 1 Manual „Parameter setting, quick reference“ (1xGB, 1xD, 1xF)

Fig. 1 Overall dimensions (in mm)

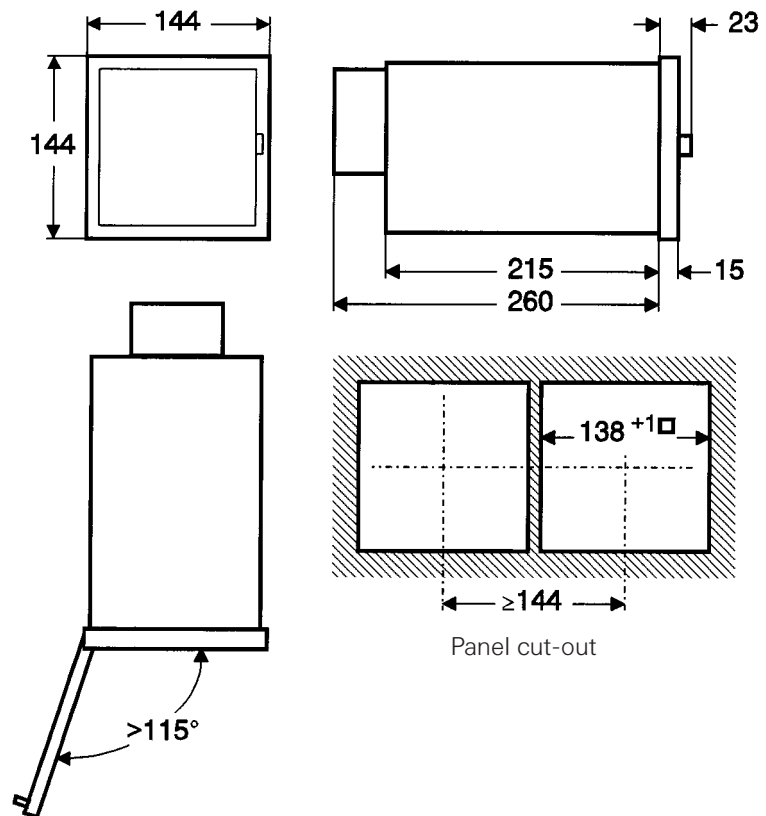
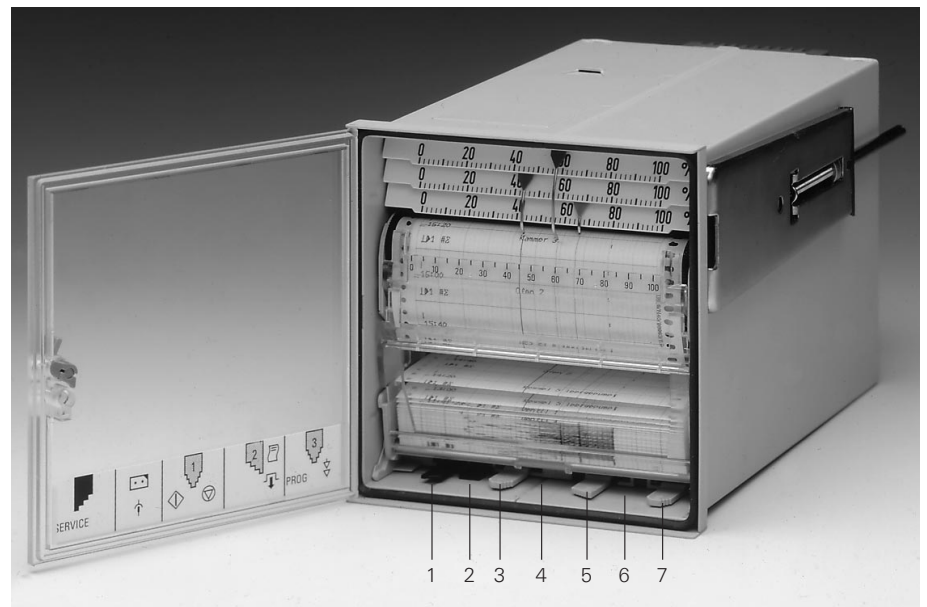

Fig. 2 Operating controls KS 3930 A/B and 3960 A/B



- 1 Chassis locking lever
- 2 PC interface connector socket
- 3 Recording start/stop
- 4 Red LED (programming status)
- 5 Catch for chart cassette
- 6 Green LED (power on)
- 7 Fast chart speed/program ON

Fig. 3 Electrical connections

Pin allocation for digital inputs/outputs (Pos. 3)

Pin	Alarm outputs
14	DO1 NO contact
2	Common
15	NC contact
3	DO2 NO contact
16	Common
4	NC contact
17	DO3 NO contact
5	Common
18	NC contact
6	DO4 NO contact
19	Common
7	NC contact
20	DO5 NO contact
8	Common
21	NC contact
9	DO6 NO contact
22	Common
10	NC contact

Pin	Control inputs
24	DI1
12	DI2
25	DI3
13	DI4
11	OV ref. potential

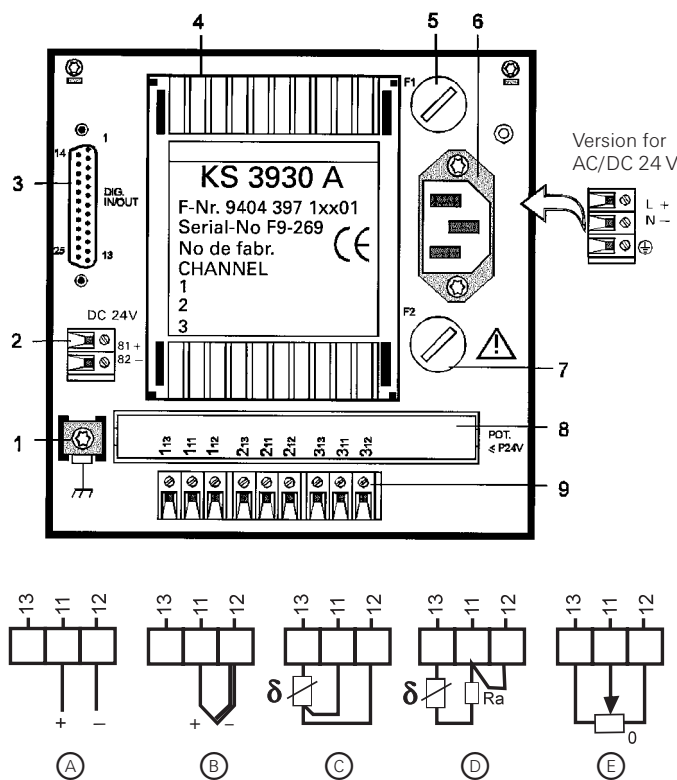

- 1) Earth terminal
- 2) Output 24 VDC (option)
- 3) Digital inputs/outputs (option)
- 4) Transformer with type label
- 5) Fuse F1
- 6) Power socket 230/115 VAC
- 7) Fuse F2
- 8) Window with channel identification for adjusting the input ranges
- 9) Input terminals for channels 1...3

- A Voltage/current
- B Thermocouples
- C Resistance thermometer in 3-wire connection
- D Resistance thermometer in 2-wire connection
- E Potentiometer

ORDERING DATA

The basic setting for all channels is: Input range 4... 20 mA, scale 0... 100%. Different settings must be specified as options.

Order no. 9404 397 . . . 01

KS 3930 A with alpha-numeric printing system

Universal input circuit (U/I / TC / RTD / R)

KS 3930 B without alpha-numeric system

Standard input circuit (U/I)

Universal input circuit (U/I / TC / RTD / R)

Number of channels 1 (red) 1
 2 (red, blue) 2
 3 (red, blue, green) 3

Supply voltage AC 230V 0
 AC 115V 1
 AC 24V 2
 DC 24V 3



Ordering example:

Pos.	Qty	Description
1.0	1	KS 3930 A 3-channel line recorder Mains supply 230 VAC Order no. 9404 397 13001
1.1	1	Option S1, fitted in Pos. 1.0 range and scale to specification: Chan. 1: 4...20mA, scale 0...100% Chan. 2: 4...20mA, scale 0...16 bar Chan. 3: Pt 100, scale -5...50 °C Order no. 9404 397 00011
1.2	1	Option Q1, fitted in Pos. 1.0 Built-in 24 VDC voltage source Order no. 9404 397 00041

OPTIONS

Must be ordered as separate items, will be fitted in recorder

Description	Order no.
Recorder features, different from the basic version	
Measuring range and scale to specification per recorder ¹⁾	Type S1 9404 397 00011 Type T1 9404 397 00021
Non-reflecting door with lock	Type D1 9404 397 00031 Type Q1 9404 397 00041

¹⁾ Please specify range and scale for each channel.

CONSUMABLES

Description	Order no.
Recording pens red (channel 1, bottom)	4012 027 45518
blue (channel 2, middle)	4012 027 45519
green (channel 3, top)	4012 027 45521
black (alphanumeric printing for KS 3930 A)	4012 027 45537
Z-fold chart¹⁾	
with 0...100 linear graduation	
no time marks	4012 027 45517
with time marks for chart speed 10 mm/h	4012 142 91451
20 mm/h	4012 142 91461
60 mm/h	4012 142 91471
blank chart	4012 027 45538
Roll chart¹⁾	
with 0...100 linear graduation	
no time marks	4012 027 45516
with time marks for chart speed 10 mm/h	4012 027 45523
20 mm/h	4012 027 45524
60 mm/h	4012 027 45525
blank chart	4012 027 45539

¹⁾ For the recorder KS 3930 A we recommend the chart without time marks, because the alpha-numeric printing system records the time regularly. Similarly, graduation lines can be printed, so that blank charts can also be used as an alternative.

ACCESSORY PARTS

Description	Order no.
Certificate with calibration protocol (first calibration)	9404 397 00101
Engineering Tool (English, German)	9404 397 00111
Adapter cable for PC interface	4012 027 45542
Recorder manual English	9499 040 44711
German	9499 040 44718
French	9499 040 44732

PARTS FOR RETRO-FITTING

for subsequent changes to a recorder

Description	Order no.
Scale strip blank	4012 027 45526
with one graduation to specification	4012 027 45527
Chart-reading rule with one graduation to specification	4012 027 45535
Digital inputs/outputs , mounting kit with instructions	4012 027 45543
Voltage source 24 VDC , mounting kit with instructions	4012 027 45544

Scale versions :

Single-channel recorder

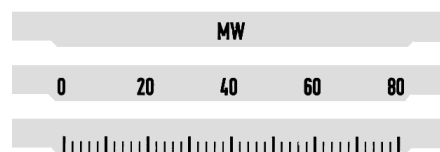

Dual-channel recorder

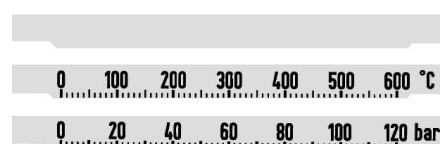

Three-channel recorder

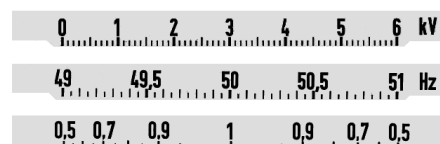

PMA
 Prozeß- und Maschinen-
 Automation GmbH
 P.O. Box 31 02 29
 D-34058 Kassel
 Tel.: +49 - 5 61 - 5 05 13 07
 Fax: +49 - 5 61 - 5 05 17 10
 e-mail: mailbox@pma-online.de
 Internet: http://www.pma-online.de

Your local representative: